

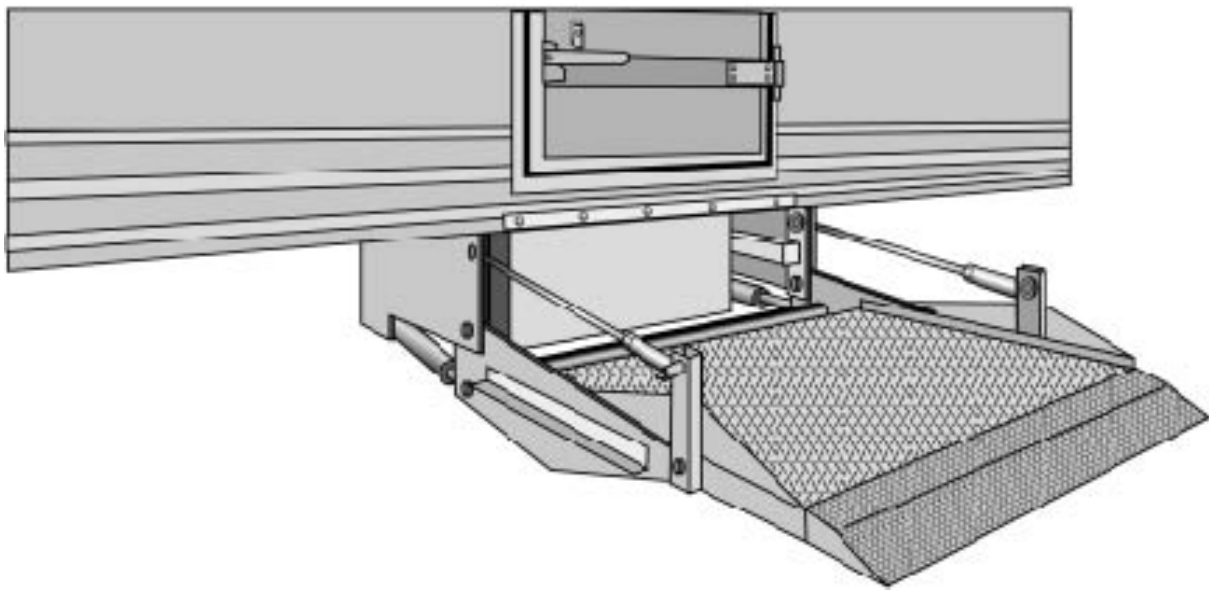

Installation Manual

TLS4500RL Hide-A-Way® Trailer Side Gate



LEYMAN MANUFACTURING CORPORATION
10900 Kenwood Road
Cincinnati, OH 45242
1-866-LEYMAN-1 • 1-866-539-6261 • 513-891-6210
Fax 513-891-4901
www.leymanlift.com
sales@leymanlift.com

TABLE OF CONTENTS

General Terminology	3
General Specifications	4
Before you install the Lift Gate	5
Pre-Installation of the Lift Gate	6
Side Door Mounting Information	7
Installation of the Lift Gate	8 - 9
Toggle Switch or Walk Around Installation	10 – 11
Charge Line	12
Grounding Recommendations	13
Wiring Diagrams – Circuit Breaker and Additional Options	14 – 15
Installation Adjustments	16
Installation of Safety Decals	17
Final Installation Inspection	18
Recommended Oils and Lubrication	19
Operating Instructions	20
Operating the Optional Emergency Hand Pump	21
Maintenance Minder 2	22 - 24
Electric / Hydraulic diagram - Reference	25
Troubleshooting Guide	26
Notes	27

GENERAL TERMINOLOGY

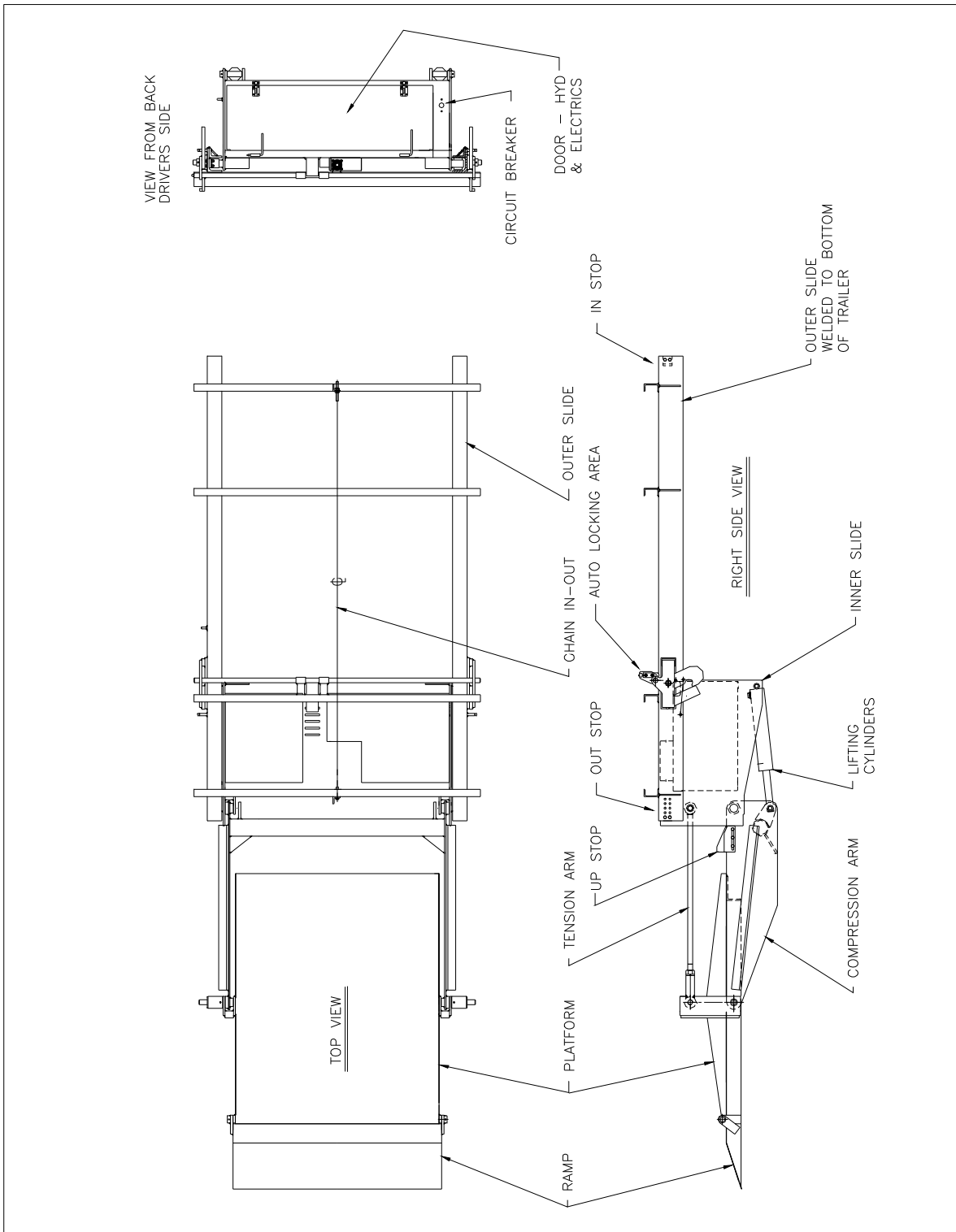

GENERAL SPECIFICATIONS

CUSTOMER: _____

MODEL: TLS4500RL

CAPACITY: 4500 lbs.

TYPE: Trailer Side Door Lift Gate

HYDRAULIC PRESSURE: 2500PSI – Up Function
800PSI – In/Out Function

OPERATION: Power up/Gravity down
Power in/out

SERIAL #: _____

MINIMUM MOUNTING SPACE REQUIREMENTS

MINIMUM SPACE REQUIREMENTS NEEDED TO INSTALL THE TLS4500 SERIES GATE.

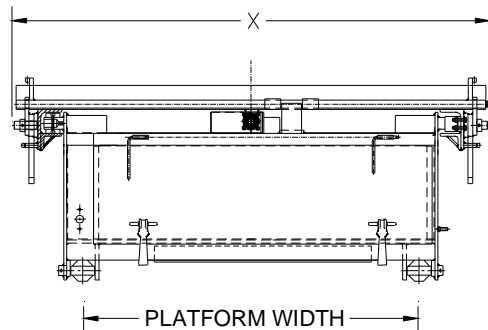
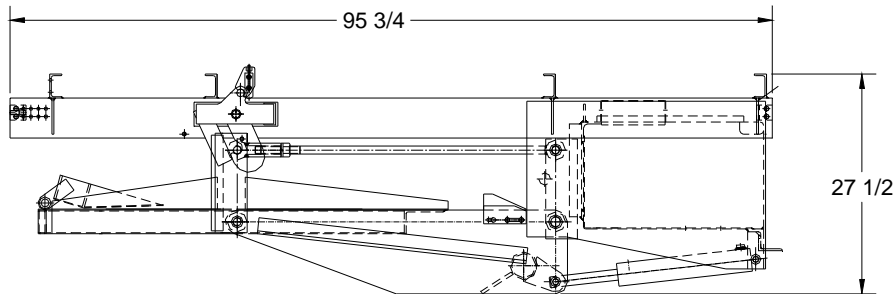

PLATFORM WIDTH	DIM. X WIDTH REQ.
42	DIM. X = 60
48	DIM. X = 66
60	DIM. X = 78
72	DIM. X = 90

BEFORE YOU INSTALL THE LIFT GATE

1. Check the lift gate for shipping damage.
2. Remove the shipping bands, etc. if the gate was shipped vertically, set the gate on the ground.
CAUTION – DO NOT INSERT FORKLIFT FORKS AT BOTTOM OF GATE NEAR DOOR.
Remove the shipping bands, etc. To set lift gate horizontal, chain or lash top cross tube near chain anchor
3. Remove the box, open and read the installation manual. Check that all major parts have arrived, such as the electrical box, optional mud flap (if ordered), etc.
4. Inspect the area under the trailer where the lift gate is to be mounted. Be sure the area is clear of obstructions where the lift gate will be installed. Check the cross member material. If the cross members are made of aluminum, the aluminum conversion kit (option #133TLS) must be ordered and used to mount the lift gate.
5. The use of a battery charger as the sole power source to operate the lift gate is unauthorized and will prevent the lift gate from working properly. The lift gate must always be operated in conjunction with at least one (1) 12 volt heavy duty lift gate battery. A minimum of 9.5 volts must be maintained in order for the DOWN valve and 10.5 volts for the IN/OUT valves to operate.
6. Read the following pages prior to beginning the installation.
 - A. Minimum mounting space requirements
 - B. Pre-installation of the lift gate.
 - C. Side door mounting information.
 - D. Installation of the lift gate.
 - E. Installation adjustments.

PRE-INSTALLATION OF THE LIFT GATE

1. Measure from the bottom of the cross members to the ground. If this measurement is less than 47 inches, spacers will not be required. This measurement must be 41.5 inches minimum in order to yield 14 inches ground clearance for the gate. If the measurement is more than 47 inches, the amount in excess of 47 inches is the height of the spacer that must be added to the four channels at the top of the Outer Slide. See Sketches 1 and 2.
2. Check the side door threshold. See Sketch 3. For the platform to properly enter the opening, dimension "B" must be at least twice the size of dimension "A".

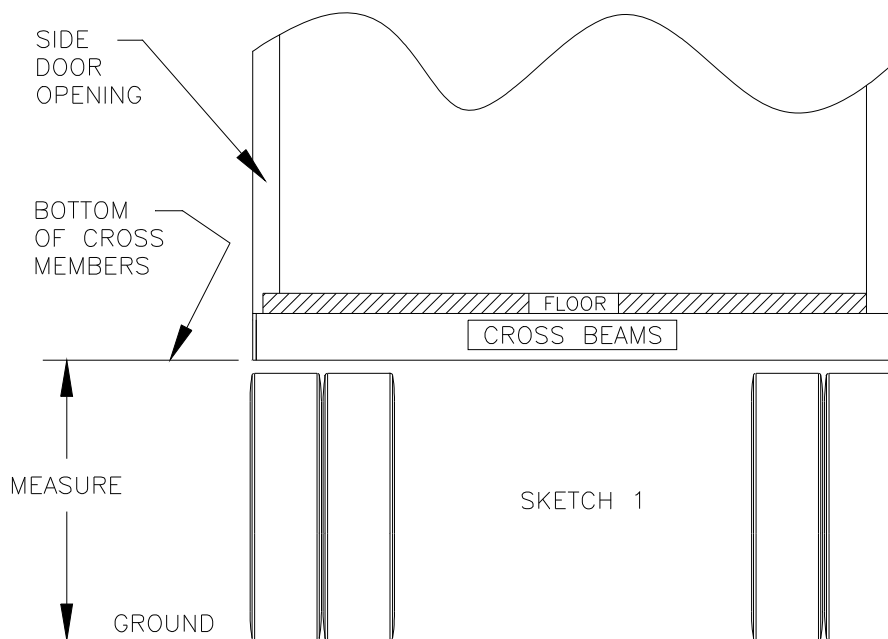

SKETCH 1

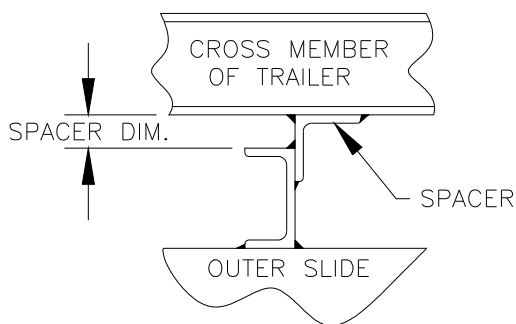

SKETCH 2

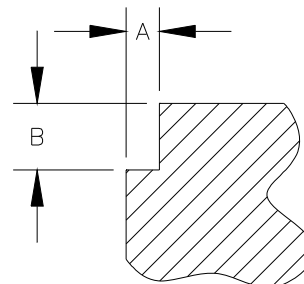

SKETCH 3

SIDE DOOR THRESHOLD

SIDE DOOR MOUNTING INFORMATION

Installation of Leyman side gates that are 42" wide are usually centered on the door opening providing that the door opening is at least 42" wide.

For installation of Leyman side gates that are wider than the door opening, we recommend the gate be offset to the rear of the trailer so when the door is open, it will not interfere with movement of the platform.

Depending on the side door threshold, the platform may not fill the gap between the floor and the platform. There are three options to correct this:

1. Notch the tip of the platform.
2. Add material to the tip of the platform (use a minimum thickness of 3/16" for proper strength.)
3. Fabricate a flip plate to span the gap.

NOTE: End user option, material is not provided by Leyman.

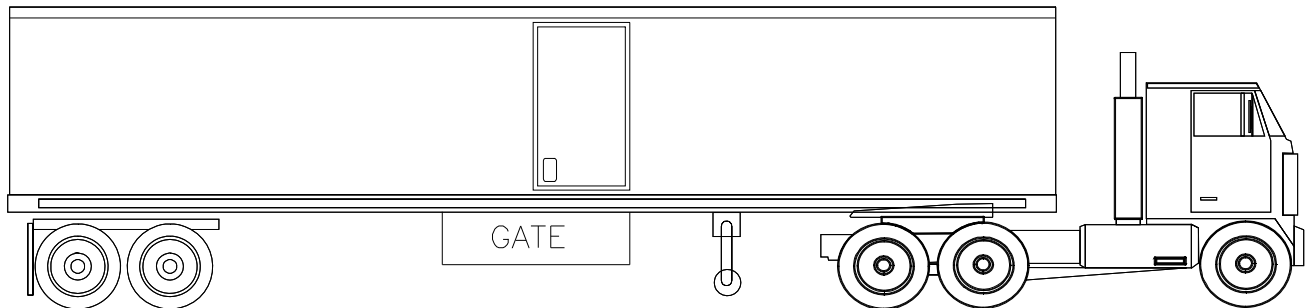

MOUNTING ON "J" CHANNELS

NOTE: FILLER MATERIAL NOT SUPPLIED BY LEYMAN

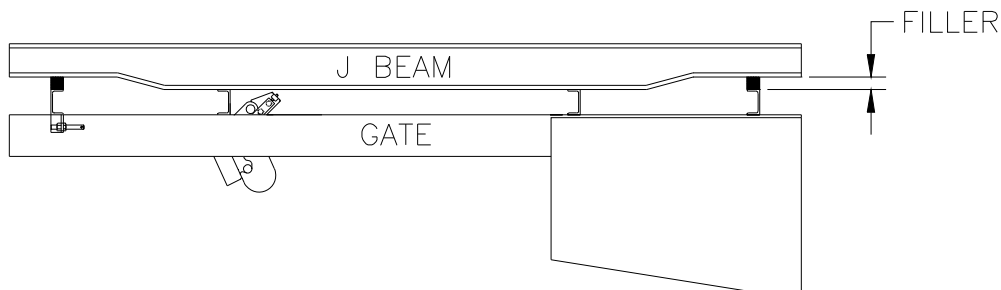

NOTE: Mounting to aluminum cross members will require the use of kit #133TLS.

INSTALLATION OF THE LIFT GATE

1. Mark the door opening on the vertical rub rail.
 - For the 42" wide gate, mark the centerline of the door opening. For all others, mark the leading edge of the door opening.
 - **NOTE:** The centerline of the 42" wide gate is the center of the chain. Mark the centerline on the channel. For all others mark the leading edge of the platform on the channel.
2. Raise the lift gate, use a lift truck. See the sketch below. Position the forks under the spreaders (the four (4) three inch channels). Spread the forks as wide as possible. **CAUTION:** Do not hit anything with the forks. Clamp the unit to the forks using two (2) "C" clamps.

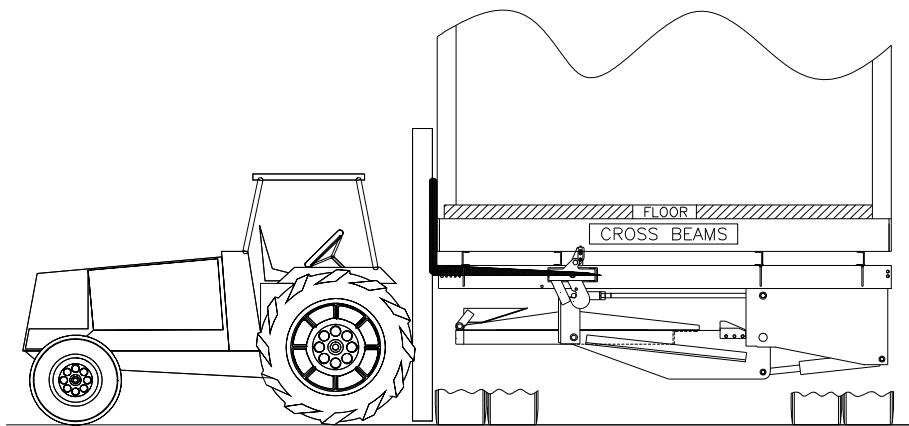

3. Pick the unit up, position it under the trailer. Line up the marks, which you put on the gate and the rub rail. The front edge of the gate's outer slide should be flush to the outside of the rub rail. Weld the four (4) corners to the cross members.
4. Mount the electrical box. See the wiring drawings for location information. Drawings are labeled "Toggle switch electrics or walk around electrics", finish wiring.
5. Install at least two (2) heavy-duty Dual Purpose or AGM batteries. Place rubber battery pads under batteries. See sketch.

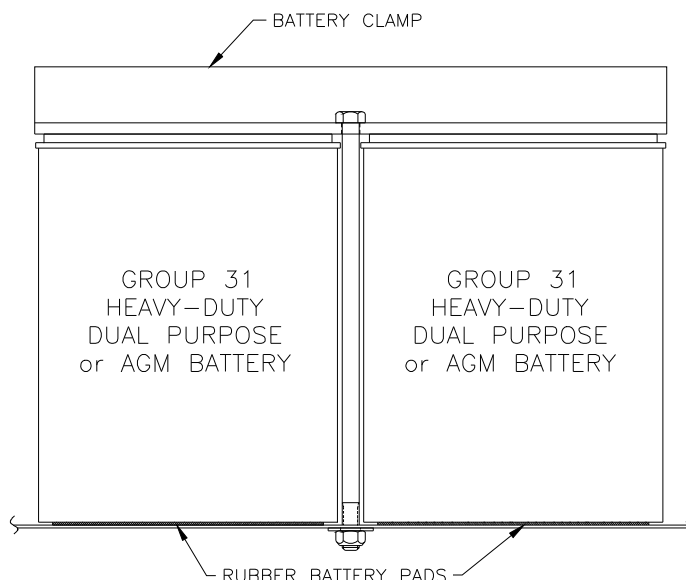

INSTALLATION OF THE LIFT GATE (cont.)

6. Fill oil tank using a recommended hydraulic oil, and install breather cap. Oil level should be 1" from top of tank with platform on ground.
7. With switches, lift the gate upward, lift up on the auto lock handle. Drop the platform down six inches. Run the gate outward. Lift the platform up to the door threshold. Check for the fit to the door opening. Alter or adjust as needed. See the Installation Adjustments page for correct order and steps.

CAUTION: Do not ride on the gate yet, when only partially welded.

8. Complete welding. Weld all channels along both sides to all of the cross members.
9. Install charge line.
10. Install any other options.
11. Make any final adjustments if needed.
12. Touch-up any paint wherever necessary.
13. Install the safety decals. Reference page 16 for general placement.
14. Perform a Final Installation Inspection. Reference page 17

TOGGLE SWITCH ELECTRICS - INSTALLATION

OPTION #182TLS

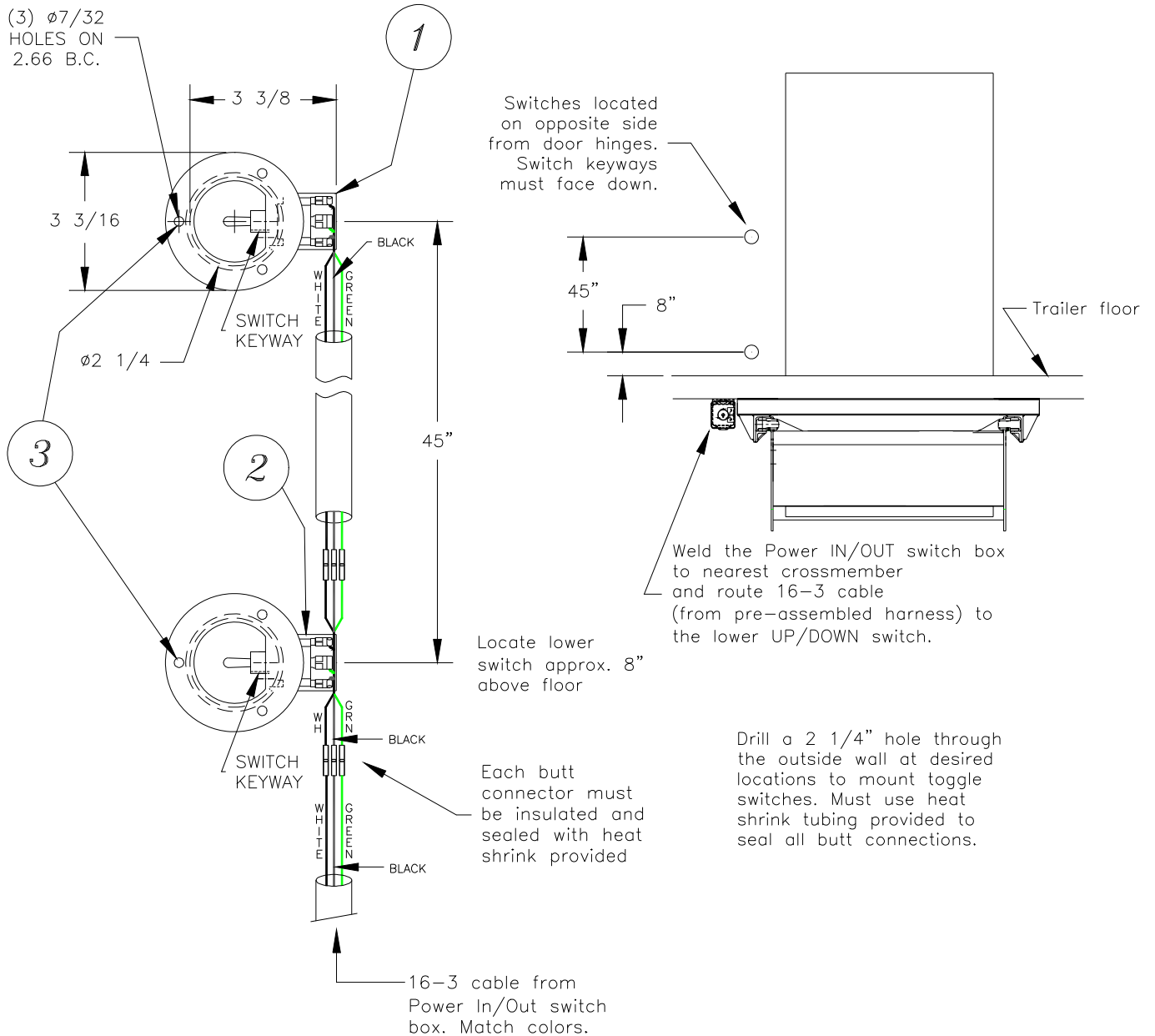

WALK AROUND ELECTRICS - INSTALLATION

OPTION #183TLS

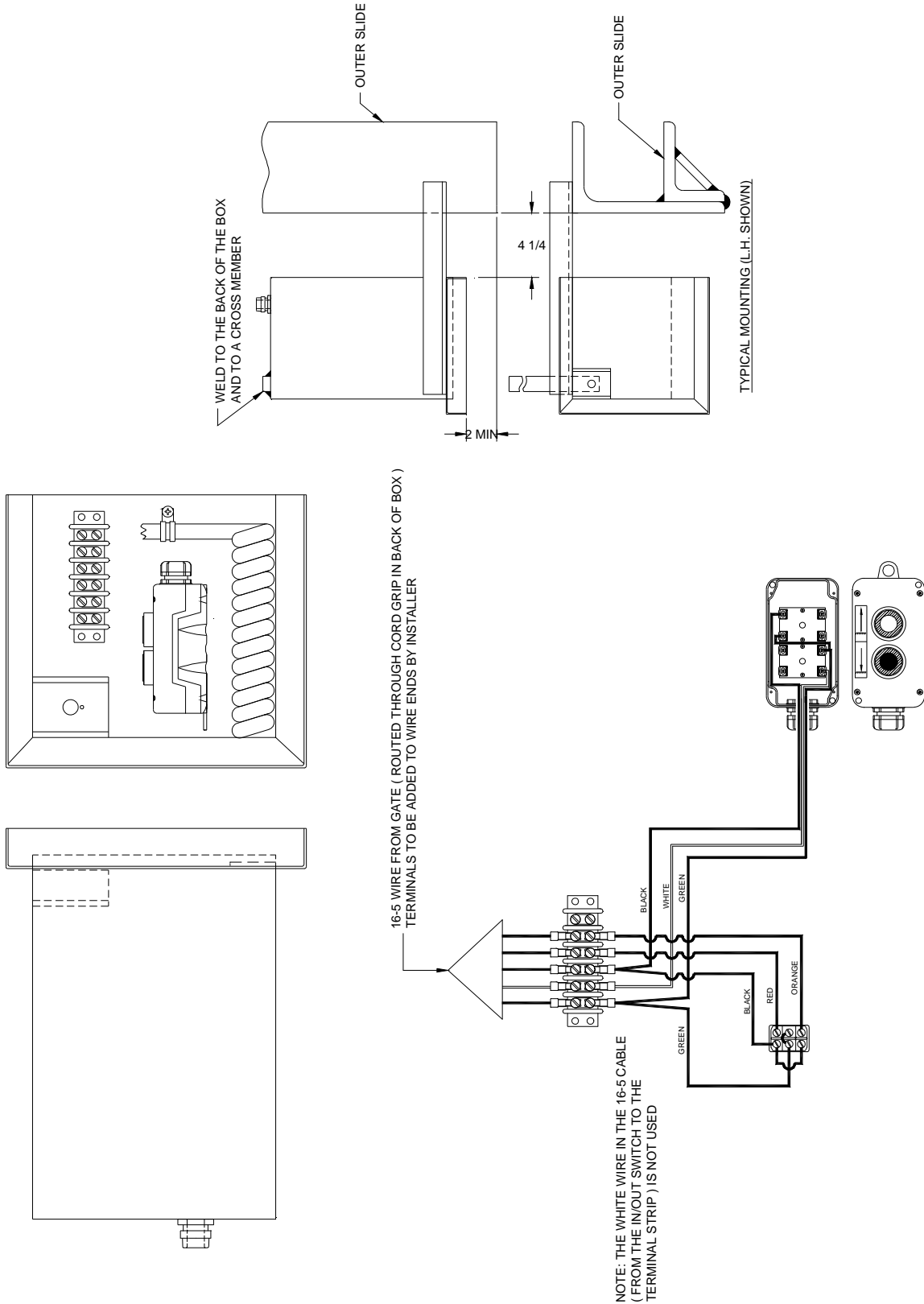

CHARGE LINE

When installing the charge line, be sure the cable goes through three (3) "I" beams at the very least, past the fifth wheel plate and the clear vinyl loom. Mount the remaining cable with loom clamps and self tapping screws to the "I" beams.

USE "0" GAUGE CABLE AT MINIMUM

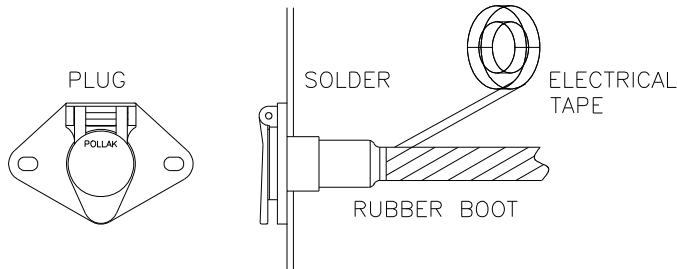

WE RECOMMEND THAT YOU USE AT LEAST A 90 AMP ALTERNATOR ON THE TRACTOR TO RECHARGE THE BATTERIES ON THE TLS™.

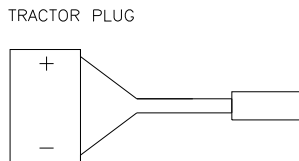
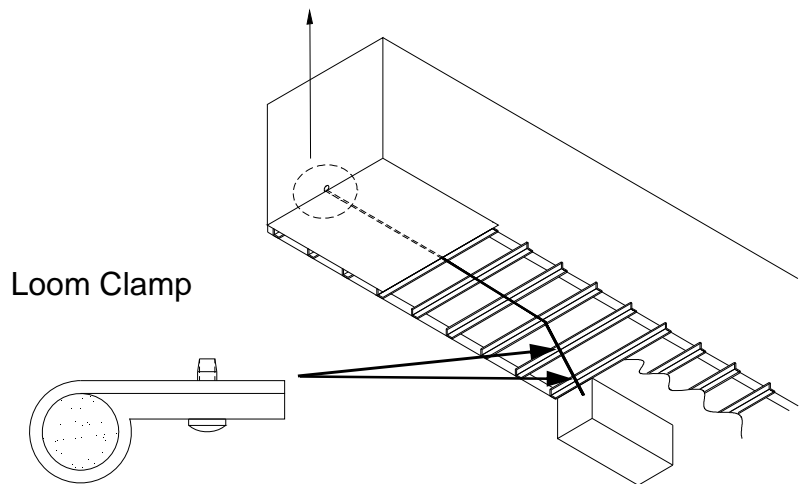

Run the power line wire with wiring harness on lift gate.

The plug that is on the tractor must have a hot wire and ground wire to the lug that plugs into the trailer.

GROUNDING RECOMMENDATIONS

FOR TRACTOR/TRAILER USING THE MAINTENANCE MINDER 2® CONTROLLER

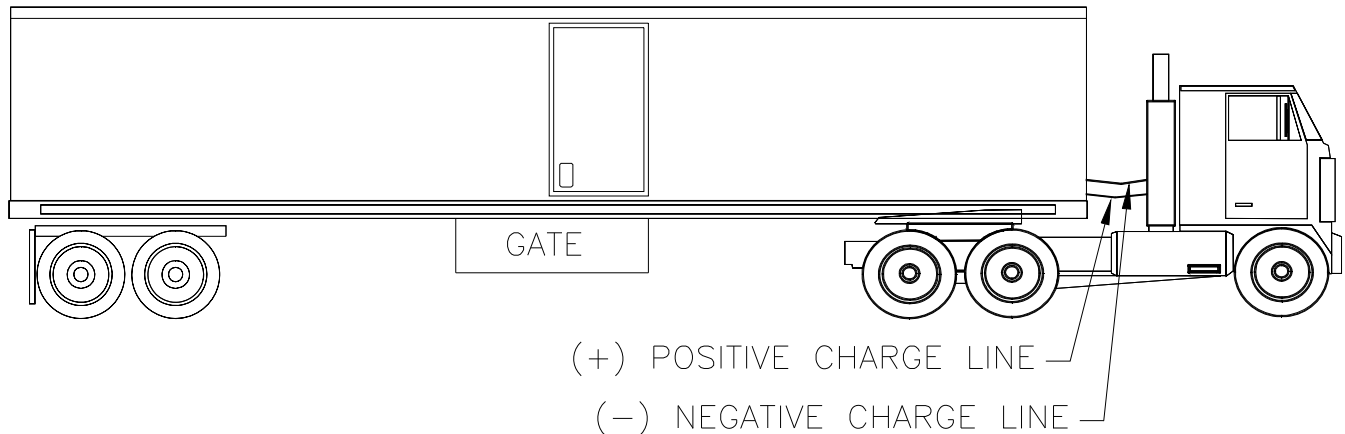

The Maintenance Minder2® requires a minimum of 10 volts in order for the TLS to operate. Utilization of a single positive cable does not provide sufficient ground. Therefore, our recommendation for grounding tractor/trailers with a TLS gate are as follows:

Two (2) cables, one (1) positive and one (1) negative, both running to the tractor batteries.

The Maintenance Minder 2® controller requires that a minimum of 8 volts be maintained under load in order for the TLS to operate.

NOTE:

The use of a battery charger as the sole power source to operate a TLS is unauthorized and will prevent the TLS from working properly. The lift gate must always be operated in conjunction with at least one (1) 12 volt heavy duty lift gate battery. A minimum of 9.5 volts must be maintained in order for the DOWN valve and 10.5 volts for the IN/OUT valves to operate.

CIRCUIT BREAKER WIRING DIAGRAM

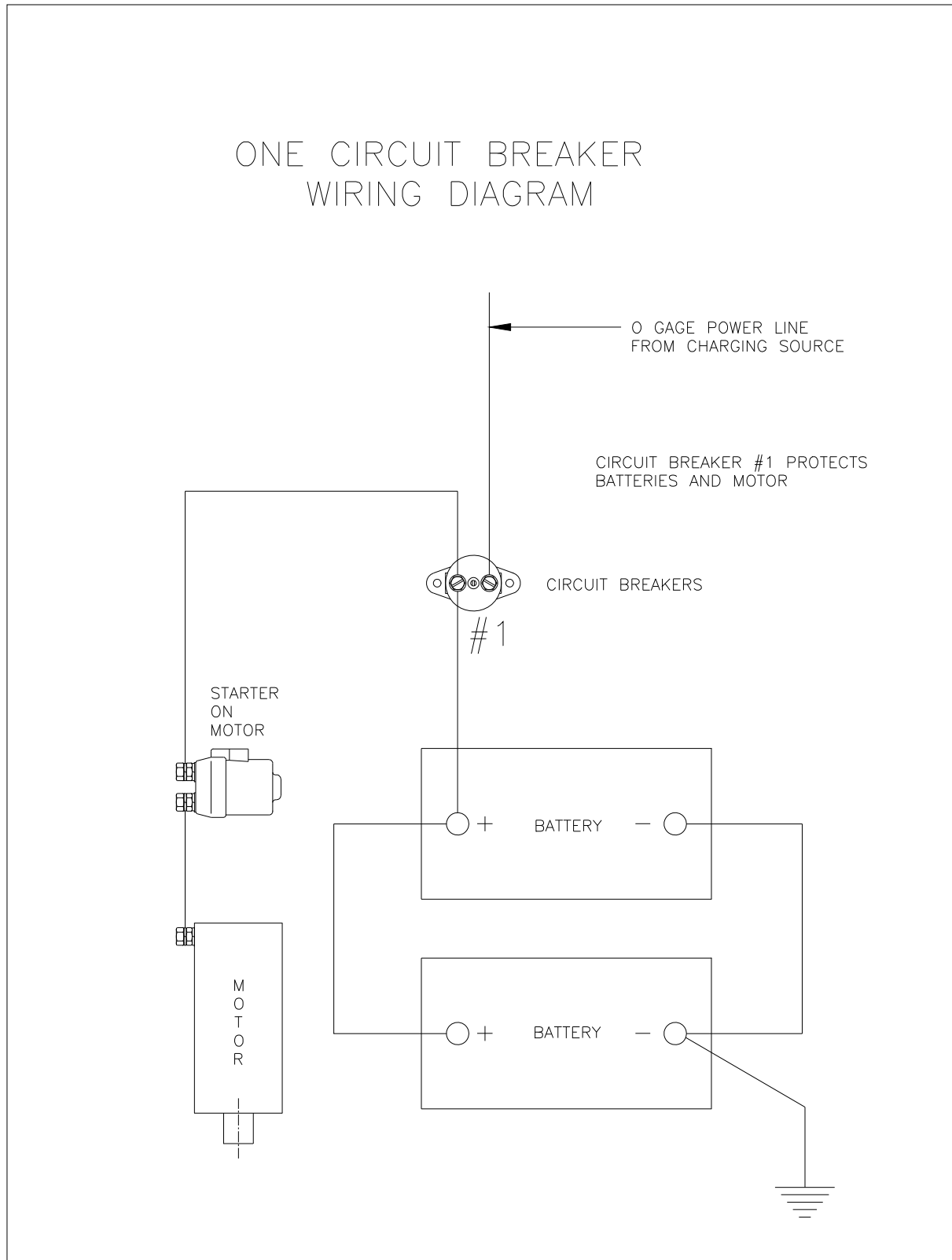

OPTION #155TLS LIGHTS AND SENSOR

ELECTRICAL CONNECTIONS

ELECTRICAL CONNECTIONS

SENSOR OUTPUT TYPE: NPN
 OMRON E2E-X18ME2 28703
 TELEMECANIQUE XS2 M30NB370

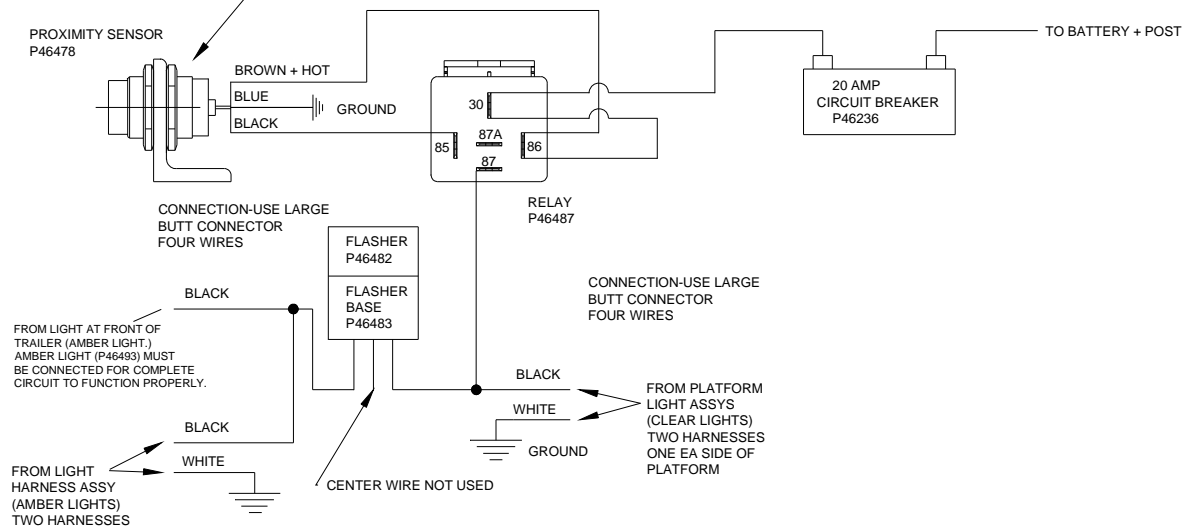

ELECTRICAL CONNECTIONS

SENSOR OUTPUT TYPE PNP (PREFERRED)
 PEPPERL-FUCHS NBB15-30GM50-E3-M OR NBB15-30GM30-E3
 BALLUFF BES 516-3028-G-E4-Y-03
 OMRON E2A-M30LS15-WP-B2 2M
 TELEMECANIQUE XS630B1PBL2

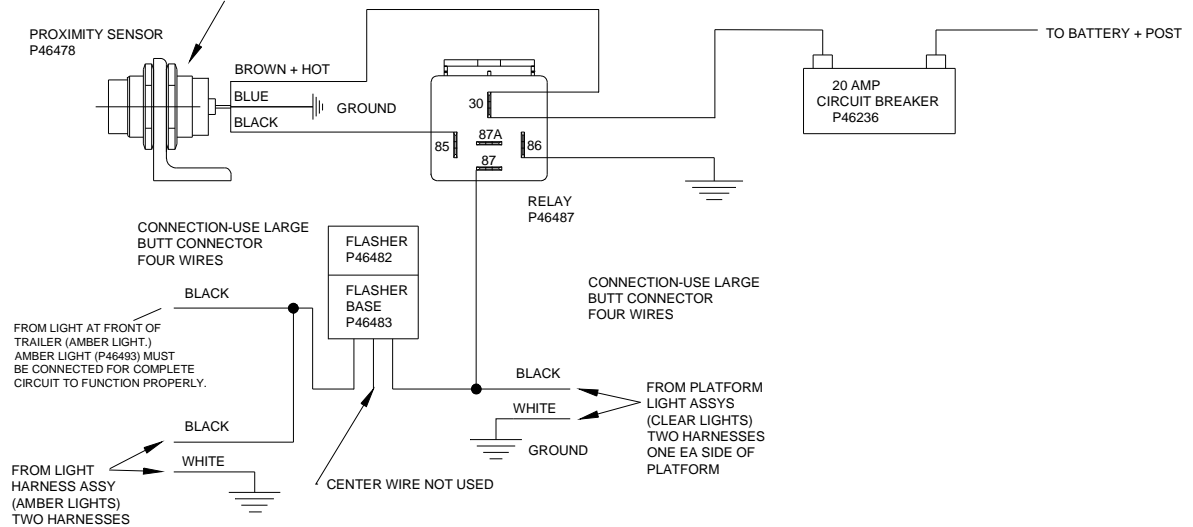

INSTALLATION ADJUSTMENTS

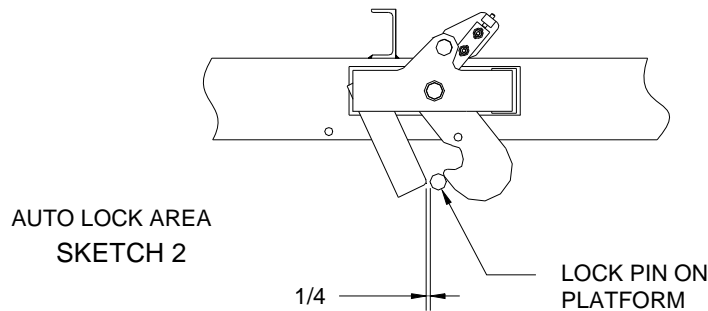
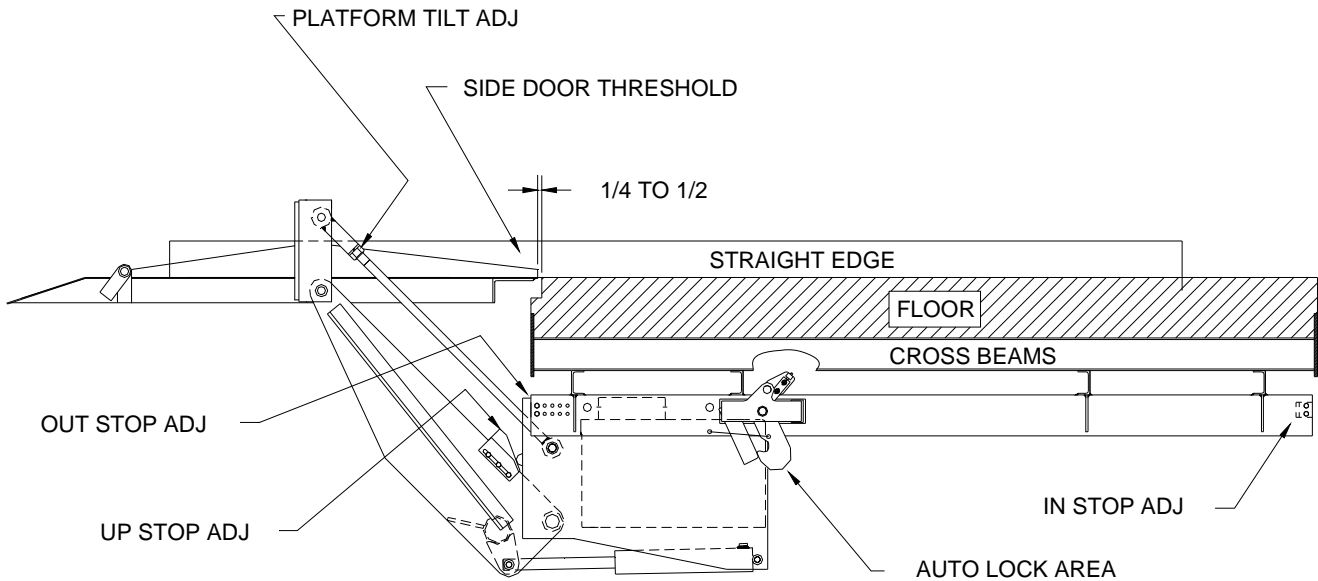

- Step 1: The platform was preset at the factory to be level to the floor of the trailer within $\frac{1}{4}$ ". With a straight edge, check this. If it is okay, proceed to step 2. If not, let the platform down to the ground. Remove the two (2) roll pins and the top tension arm pivot pins (one on each side).
NOTE: One full turn moves the tip of the platform $\frac{1}{4}$ " (turn the end in, this moves the tip of the platform up, unscrewing moves the tip of the platform down.)
 Make necessary adjustments. Replace pins, raise the platform up and check. Repeat if necessary. Replace roll pins.
NOTE: Each side must be adjusted the same amount.
CAUTION: If this adjustment has been made, the in-stop must be adjusted to provide the $\frac{1}{4}$ " clearance with the auto locking pin (see sketch 2).
- Step 2: Adjust the up stops. Platform should be even with the floor of the trailer. After adjusting, tack weld the stops in place.
- Step 3: Adjust the out stops. The tip of the platform should be $\frac{1}{4}$ " to $\frac{1}{2}$ " from the edge of the threshold.
- Step 4: Adjust the in stops. See sketch 2 and adjust for the $\frac{1}{4}$ " dimension.

INSTALLATION OF SAFETY DECALS

Apply decals in a prominent and easy-to-read location.

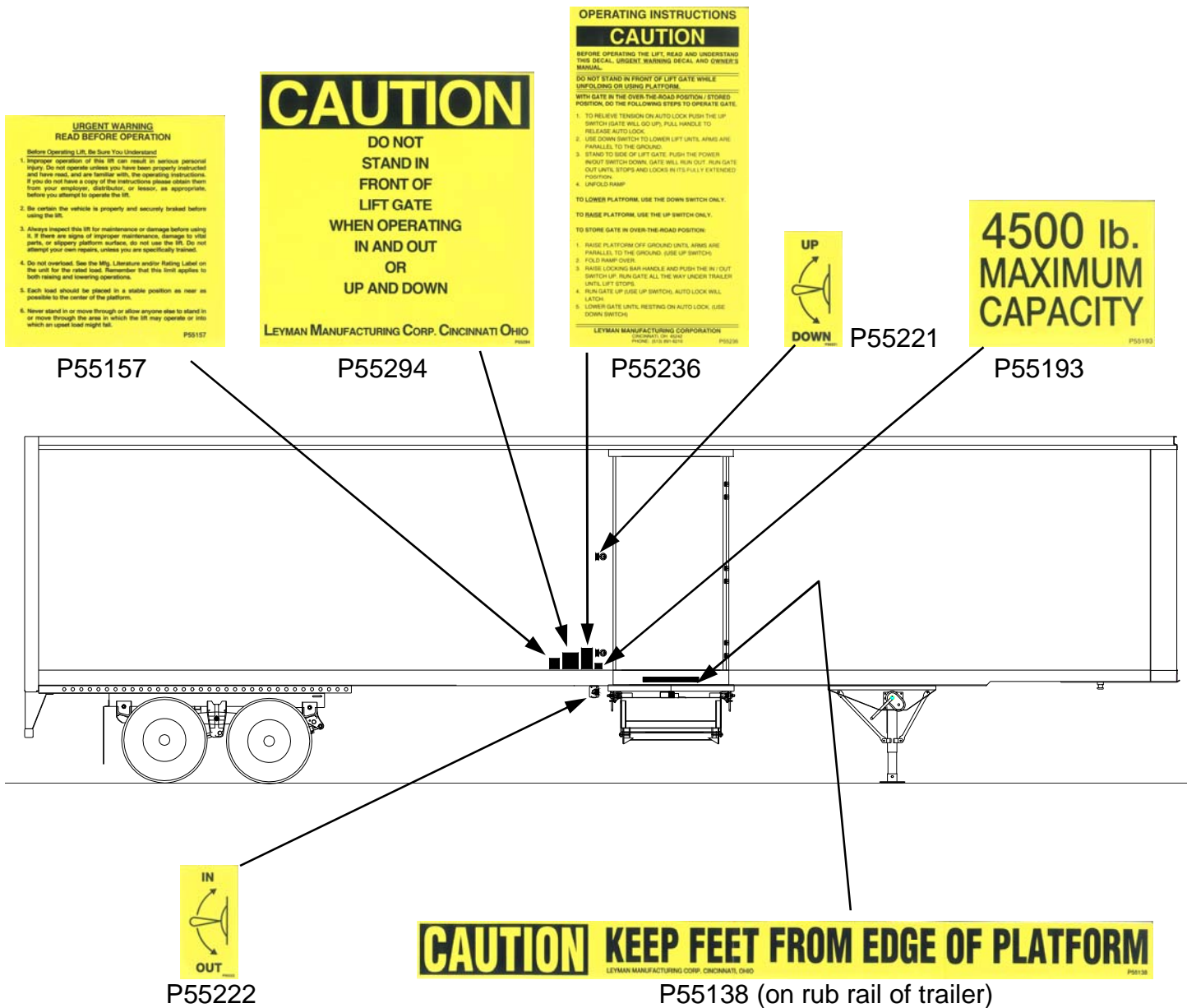

Leyman Manufacturing will replace safety stickers at any time **FREE OF CHARGE**.

FINAL INSTALLATION INSPECTION

CUSTOMER:		
LOCATION:		
VEHICLE#:	LIFT GATE MODEL#:	LIFT GATE SERIAL#:

√ = OK N = NOT APPLICABLE

	WELDING/ADJUSTMENTS
	Gate is welded secure to bottom of cross members
	Up stops are adjusted (to set platform flush with floor of trailer) and tack welded to compression arm
	Out stops adjusted (the platform should be 1/4" to 1/2" from the edge of the threshold)
	In stops adjusted (the auto lock pin should be 1/4" gap from hook)
	ELECTRIC'S
	Check that battery holds downs are anchored securely
	Check batteries for proper charge level.
	Check all wiring connections for tightness (batteries, switches, etc.) and sealer has been applied.
	Inspect and check all circuit breakers
	Charge line/power line (through cross members with rubber grommets if this is the preferred method)
	Charge line/power line (clamped to bottom of cross members with loom clamps)
	Control wiring has been properly routed and secured
	Check operation of toggle switches (or walk around if equipped)
	Check operation of optional lights if equipped
	HYDRAULIC/GREASE
	Check reservoir for correct amount of fluid. Fluid level should be within 1" of the top of the tank. Platform should be down on the ground when checking fluid level. Refer to the Recommended hydraulic oil / lubrication page for type of oil and capacity.
	Check hydraulic hoses and fittings for leaks
	Check hydraulic cylinders for leaks
	OPERATION OF GATE
	Raise and lower lift gate. Observe for correct operation
	Operate lift gate in-out. Observe for correct operation
	PAINTING AND SAFETY STICKERS
	Repaint where needed. Use Leyman Extreme Shield® touch-up kit provided.
	Check hydraulic cylinder rods for over spray
	Install all safety and operation stickers

SERVICED BY: _____ DATE: _____

RECOMMENDED HYDRAULIC OILS/LUBRICATION

HYDRAULIC OILS	Manufacturer	Type	Temp. Range
Level 1 Normal Conditions	Mobile	DTE 11	-15° F to + 150° F
Industry standard ISO-15	Shell	TELLUS-T15	-15° F to + 150° F
	Exxon	UNIVIS-N15	-15° F to + 150° F
Level 2 Cold Conditions	Mobile	AERO-HFA	-50° F to + 80° F
	Shell	AERO FLUID#4	-50° F to + 80° F
	Exxon	UNIVIS-HVI13	-50° F to + 80° F
	Mil	H-5606	-50° F to + 80° F

HYDRAULIC TANK CAPACITY

2 ½ gallons

LUBRICATION

Grease

Cam Rollers, Idler Sprockets,
Main Auto-Lock shaft,
Cylinder base pins

Lithium Base Grease

BATTERIES

Two (2) 12-Volt DC Group 31 Heavy-Duty Dual Purpose or AGM

ELECTRICAL COMPONENTS CONNECTIONS

Use Fluid Film Rust & Corrosion Protection by Eureka, except on Start Solenoid

On Start Solenoid, use Color Guard by Loctite, or Liquid Electrical Tape

AMPERAGE DRAW OF MOTOR

When raising platform (empty) approximately 115 AMPS @ 13.5 volts.
At bypass approximately 235 AMPS @ 13.5 volts

LIFTING PRESSURE SETTING

With platform at floor level and pump in bypass 2500 PSI

IN-OUT PRESSURE SETTING

When sliding gate in-out and pump in bypass 800 PSI

MINIMUM VEHICLE FLOOR HEIGHT LADEN

With any size of platform – vehicle floor height 48”

MAXIMUM VEHICLE FLOOR HEIGHT UNLADEN

With any size of platform – vehicle floor height 58”

APPROXIMATE TIMES EMPTY AT 80° F WITH 2 GROUP 31 BATTERIES

Time up: 14 – 18 seconds
Time down(gravity down): 12 –16 seconds

OPERATING INSTRUCTIONS

Before operating the lift gate, read and understand this manual and all urgent warning decals.

Do not stand in front of the lift gate while unfolding or using the platform.

With the gate in the over-the-road (stored) position, proceed with the following steps:

1. To relieve the tension on the auto lock, push the up switch (the gate will go up), pull the handle to release the auto lock.
2. Use the down switch to lower the lift until arms are parallel to the ground.
3. Stand to the side of the lift gate. Push the power in/out switch down. Gate will run out. Run the gate out until it stops and locks into its fully extended position.
4. Unfold the ramp.

To lower the platform, use the down switch only.

To raise the platform, use the up switch only.

To store the gate in the over-the-road (stored) position:

1. Raise the platform off the ground until the arms are parallel to the ground.
2. Fold ramp over.
3. Raise locking bar handle and push the in/out switch upward. Run the gate all the way under the trailer until the lift stops.
4. Run gate up (use the up switch). The auto lock will latch.
5. Lower the gate using the down switch only until resting on the auto lock.

OPERATING THE EMERGENCY HAND PUMP

If an emergency hand pump was supplied with this lift gate, its intended use is to restore the gate to the transit position.

CAUTION: Do not try to operate the power unit when using the hand pump.

Steps to secure the gate, so the trailer can be moved:

1. Remove the pump handle from the holder and insert into the hand pump socket.
2. Raise the platform off the ground about 6", pump up/down.
3. Retract the gate, disconnect the in/out chain and manually push the gate under the trailer all the way until it stops.
4. Pump the gate until fully up and engaged in the Auto Lock hooks.
5. With the handle, unscrew the valve on the bottom of the hand pump. This will let the gate down into it's over the road position.

MAINTENANCE MINDER 2[®] OVERVIEW

Power unit is equipped with the Maintenance Minder 2[®] Controller. It will:

- Automatically keep track of maintenance intervals and warn the user when maintenance is due, based on the number of lifts.
- Record low voltage occurrences.
- Record of high temperature faults.
- Record of maximum run time faults, when a single operation exceeded the maximum continuous run time limit.
- Give helpful trouble-shooting information on MENU 4, “Last Lift Info”.

FAULTS CODES

A decal in the power unit enclosure lists the following signal codes for these faults:

1 BEEP	Service Fault (reached the number of lifts when maintenance is due)
2 BEEPS	Low Voltage Fault (check battery condition and power line connections)
3 BEEPS	Max. Time Fault (exceeded the maximum continuous run time allowed)
4 BEEPS	High Temperature Fault (unit will not run until motor cools)

All faults signals will be repeated FOUR times, except the Service Fault signal. Controller will prevent power unit from operating during the time period when a fault signal is sounding (about 5 to 10 sec.) except for the Service Fault signal. The controller is also equipped with an anti-doorbelling feature, which prevents rapid ON/OFF operation of the power unit.

RESETTING after MAINTENANCE IS PERFORMED

To RESET the Maintenance Minder 2[®] after maintenance has been performed:

1. Go to MENU 2, hit “ENTER”, and toggle down to the “Reset All Info” screen.
2. Press and hold the hidden RESET button under Maintenance Minder 2[®] logo at top of faceplate.
3. Follow the instructions on the screen regarding a second button, which must be pressed simultaneously to complete the reset operation.



MAINTENANCE MINDER 2[®] CONTROLLER MENUS

(Press MENU)

MENU 1 – LIFT GATE INFO

(Press ENTER, then ARROW DOWN for each item)

Model Number, Serial Number, Manufacture Date, Vehicle ID, Hardware Version, Firmware Version, Software Version.



(Press MENU and ARROW DOWN once)

MENU 2 – PERIOD INFO (data for current maintenance period)

(Press ENTER, then ARROW DOWN for each item)

Number of Lifts (gives the number during this maintenance interval and the set number when maintenance is due)

Motor ON (total motor run time in minutes for this maintenance period)

Service Fault (number of times gate was operated PAST the maintenance limit)

Max. Time Faults (times motor exceeded its maximum allowable continuous run time)

High Temperature Faults (times thermal switch in motor tripped, if switch provided)

Low Voltage Faults (times low voltage occurred)

Reset all Info (Reset data after performing maintenance, once maintenance limit is reached – see reset instructions on previous page)



MAINTENANCE MINDER 2[®] CONTROLLER MENUS

(Press MENU and ARROW DOWN twice)

MENU 3 – LIFE TIME INFO (data for the total life time of the gate)

(Press ENTER, then ARROW DOWN for each item)

Same items will appear as under PERIOD INFO, except this is LIFE TIME data.

Reset History (reviews history for each maintenance interval)

Press ENTER, then ARROW DOWN to show history. Most recent period is the highest #. Screen shows Period #, # of Lifts, and Total Run Time in minutes.



(Press MENU and ARROW DOWN three times)

MENU 4 – LAST LIFT INFO (Trouble Shooting Screen – it records data that occurred during the last lift made)

(Press ENTER, then ARROW DOWN for each item)

Supply Voltage (first voltage is the minimum voltage that occurred during the last lift – if below 6 volts gate will stop / second voltage is the supply voltage just before gate operation, must be at least 10 volts).

Motor ON (motor run time in seconds during last lift, gate will stop at 180 seconds).

Window Time (time in milliseconds during the last lift that the voltage dropped in between 6 and 8 volts – must not be any longer than 3 seconds or gate will stop).



NOTE:

Controller has an anti-doorbelling feature. Motor will not operate if UP switch is toggled rapidly. This prevents welding of the start solenoid contacts.

WIRING / HYD. DIAGRAM (MM2 + TEMP. SWITCH)

MONARCH POWER UNIT

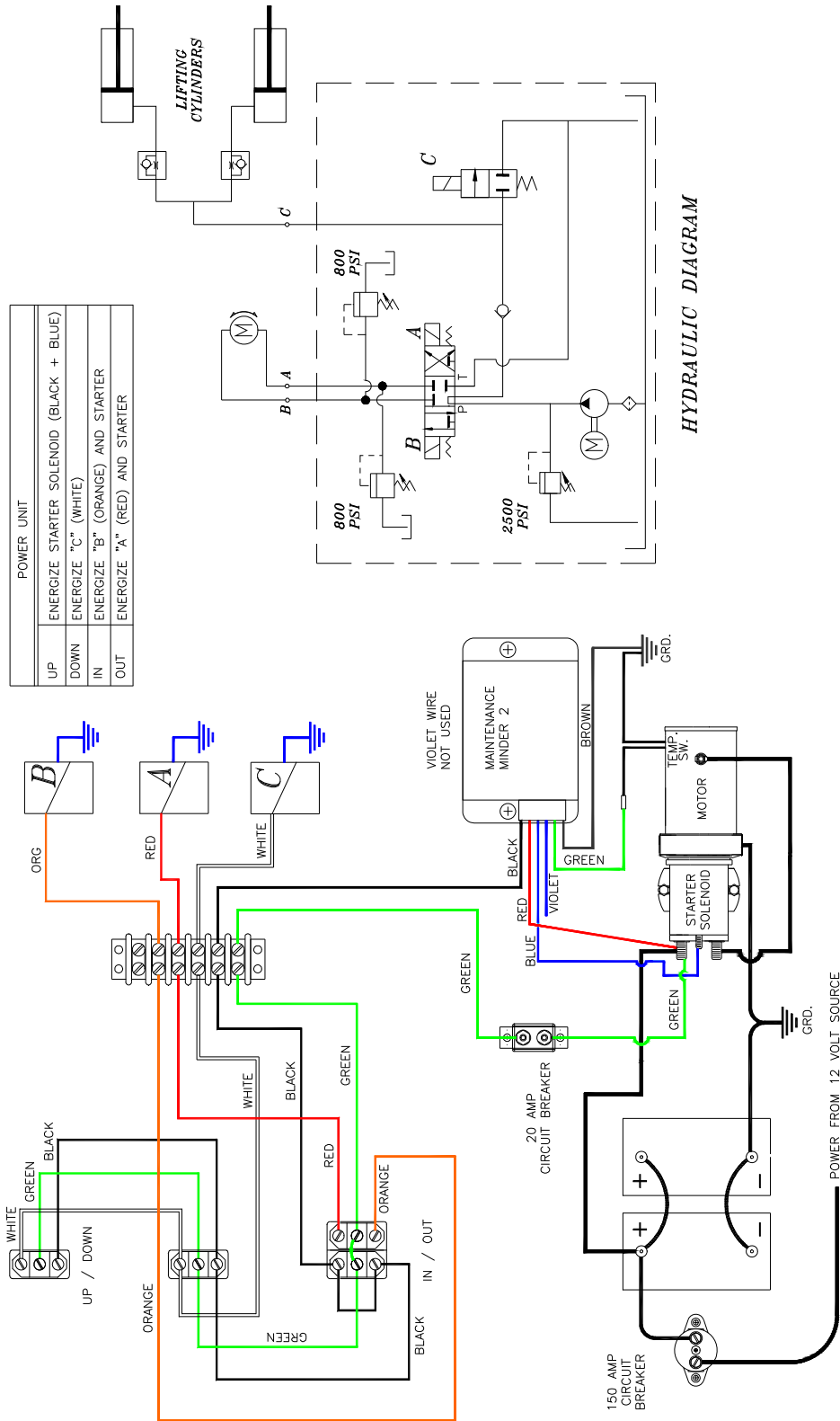

10/08 P55345

TROUBLESHOOTING GUIDE

PROBLEM	PROBABLE CAUSE	REMEDY
The motor is running, but the platform will not go up or reach the floor of the vehicle.	<ol style="list-style-type: none"> 1. Insufficient oil in power unit tank. 2. Platform is over-loaded. 3. Pressure setting is low. 	<ol style="list-style-type: none"> 1. Fill tank to the appropriate level. 2. Load only to the rated capacity. Remove some product if necessary. 3. Check and adjust the pressure to the proper setting.
The platform will not go up or reach floor level and the motor does not run.	<ol style="list-style-type: none"> 1. Low battery. Check Maintenance Minder 2[®] for Low Voltage faults. 2. Tripped circuit breaker. 3. Power line is loose. 4. Bad motor, starter or switch 	<ol style="list-style-type: none"> 1. Recharge or replace battery. 2. Reset the circuit breaker. 3. Check the connections. If loose, tighten. Check for corrosion and clean if necessary. 4. To test-push the UP switch, if motor does not run, jump the two large terminals on the starter solenoid. The motor should run, if not, the motor is bad. If it does run, the solenoid is bad or is not getting a signal from the switch or the MM2. Use a test light to check.
Platform will not lower.	<ol style="list-style-type: none"> 1. Low battery. Need 9.5 volts to activate the DOWN valve coils. 2. Bad ground or poor electrical connections. 3. Solenoid valve not opening. 4. Mechanical obstruction in gate. 	<ol style="list-style-type: none"> 1. Recharge or replace battery. 2. Check connections, if loose-tighten. Check for corrosion and clean if necessary. 3. Drain valve "C" valve (white wire) must activate when DOWN switch is pushed. Use test light to check. 4. Visually check.
Platform creeps down when DOWN function is NOT activated.	<ol style="list-style-type: none"> 1. Hydraulic leak. 2. Defective piston seal in cylinder. 3. "C" valve (white wire), or check valve not closing. 4. Drain valve at base of optional Hand Pump may be open. 	<ol style="list-style-type: none"> 1. Visually check for leaks. 2. Replace seals or cylinder. 3. Clean and inspect. 4. Check to see if valve on Hand Pump is closed tightly. Use end of Hand Pump handle.
Platform goes down slowly when DOWN function is activated.	<ol style="list-style-type: none"> 1. Check for obstructions or damage to arms. 2. Restricted or pinched hydraulic lines. 3. "C" valve (white wire) not fully opening. 4. Incorrect hydraulic oil for cold weather operation 	<ol style="list-style-type: none"> 1. Visually check. 2. Check for bent or pinched lines. 3. Clean and inspect. 4. Use recommended hydraulic oils for conditions present.
Gate will not go OUT and/or IN.	<ol style="list-style-type: none"> 1. Check for obstructions or binding in rails. 2. Low battery. Check Maintenance Minder 2[®] for Low Voltage faults. Need 10.5 volts to activate the IN/OUT valve coils 3. Tripped circuit breaker. 4. Power line is loose. 5. Bad motor, starter or switch. 	<ol style="list-style-type: none"> 1. Visually check. Check Side Button adjustment 2. Recharge or replace battery. 3. Reset the circuit breaker. 4. Check the connections. If loose, tighten. Check for corrosion and clean if necessary. 5. To test: push OUT switch and motor does not run, jump the two large terminals on the starter solenoid. The motor should run, if it does not run, you have a bad motor. If it does run, the solenoid is bad or it is not getting a signal from the switch. Use test light to check (OUT is "A" valve "red wire", IN is "B" valve "orange wire").

